

Вытяжной тросовый датчик



Серия НХ

- **Диапазоны измерений 0-50...50000 мм**
- **Выход: положение и скорость-положение**
- **Нелинейность $\pm 0,1$ % диапазона измерений**
- **Аналоговый, TTL, HTL, счётчик числа оборотов**
- **Измерительный трос из нержавеющей стали или заключённый в полиамидный кожух**
- **Рабочая температура -25...+95 °C**
- **Оptionная защита входа NEMA 6 (IP68)**

Мы оставляем право изменять характеристики без предварительного уведомления.

WayCon Positionsmesstechnik GmbH

email: info@waycon.ru

internet: www.waycon.ru

Head Office

Mehlbeerenstr. 4

82024 Taufkirchen

Tel. +49 (0)89 67 97 13-0

Fax +49 (0)89 67 97 13-250

Дистрибьютор в России

ЗАО "Сенсор Системс"

Москва, ул.Перовская, 65/1

Tel. + 7 (495)649 63 70

Fax + 7 (495)649 63 70

HX

UniMeasure

GENERAL CONSTRUCTION FEATURES

MEASUREMENT RANGES TO 80" (2 m)

Integral wire rope dust wiper

Anodized aluminum/
stainless steel Housing
(All stainless optional)

Low friction shaft seal

O-ring sealed sensor/
mechanism chamber

Extremely rigid
2 point mount

Small footprint mounting base

Fig. 1

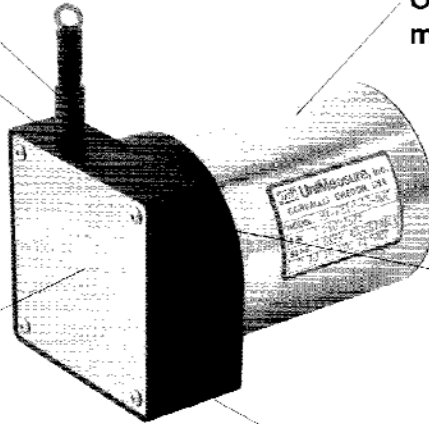

ENVIRONMENTALLY SEALED

MEASUREMENT RANGES FROM 100" (2.5 m) TO 2000" (50 m)

Integral wire rope dust wiper

Low friction
shaft seal

316 Stainless Steel
mounting base

High impact, chemical
resistant polyurethane
cover (both ends)

O-ring sealed sensor/
mechanism chamber

Extremely rigid
2 point mount

Fig. 2

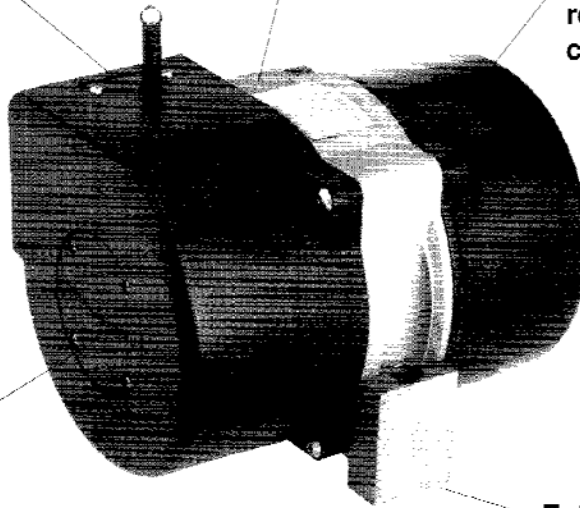

ENVIRONMENTALLY SEALED

See Table 4 (page 8) for additional mechanical specifications

HX-PA SERIES



RATIOMETRIC VOLTAGE OUTPUT

Utilizing a precision potentiometer, the UniMeasure HX-PA series position transducer provides basic absolute positioning with an analog output. With a steady state input voltage, and with the potentiometer connected as a voltage divider, the ratiometric output voltage is directly proportional to wire rope extension. The unit will function with any input voltage up to 25 volts maximum. To obtain best output linearity, the input voltage should be well regulated.

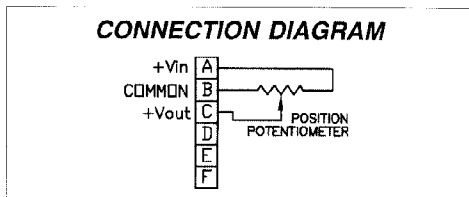

MODEL NUMBER CONFIGURATION

HX-PA- - - -

Measurement Range Designator from standard ranges shown in Table 4, page 8

Option designators from **OPTIONS** list (page 9) in order of appearance on **OPTIONS** list

General

Available Measurement Ranges See Table 4, Page 8
Sensing Device Precision Potentiometer
Connector MS3102E-14S-6P
Mating Connector (included) MS3106E-14S-6S

SPECIFICATIONS

Performance

Linearity	
2", 3", 4" & 5" Ranges ±0.25% Full Scale
10", 15", 20" & 25" ±0.15% Full Scale
All other ranges ±0.10% Full Scale
Repeatability ±0.015% Full Scale
Resolution Essentially Infinite

Electrical

Input Impedance 1000 Ω ±10%
Output Impedance 0 to 1000 Ω
Excitation Voltage 25 Volts Max. AC or DC
Nominal Output Voltage $\frac{990}{\text{Range in Inches}}$ mV/inch
(Use total measurement range in calculation) $\frac{990}{\text{Range in mm}}$ mV/mm

Environmental

Thermal Coefficient of Sensing Element ±100 PPM/°C Max.
Operating Temperature -25°C to 95°C
Operating Humidity 100%
Shock 50 G @ 0.1 ms Max.
Vibration 10 Hz to 2000 Hz, 15 G peak
Ingress Protection	
Exclusive of Wire Rope Area NEMA 4 (IP-65)
Optional Ingress Protection NEMA 6 (IP-68)

HX-PB SERIES

BRIDGE CIRCUIT VOLTAGE OUTPUT

The UniMeasure HX-PB series transducer includes the sensing potentiometer in a bridge circuit with adjustable zero and span controls. The completely passive circuit gives a maximum output voltage at maximum span setting of approximately 18% of the input voltage. The span adjustment allows for easy interface to a bridge amplifier. With zero position adjustable to anywhere within the total range of the transducer, voltage output is positive when extending the cable from the selected zero position and is negative when retracting from zero.

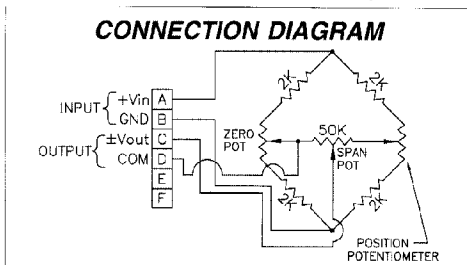

MODEL NUMBER CONFIGURATION

HX-PB- - - -

Measurement Range Designator from standard ranges shown in Table 4, page 8

Option designators from **OPTIONS** list (page 9) in order of appearance on **OPTIONS** list

General

Available Measurement Ranges See Table 4, Page 8
Sensing Device Precision Potentiometer
Connector MS3102E-14S-6P
Mating Connector (included) MS3106E-14S-6S

SPECIFICATIONS

Performance

Linearity	
2", 3", 4", & 5" Ranges ±0.25% Full Scale
10", 15", 20" & 25" ±0.15% Full Scale
All other ranges ±0.10% Full Scale
Repeatability ±0.015% Full Scale
Resolution Essentially Infinite

Electrical

Input Impedance 1.25KΩ
Output Impedance 1.25KΩ at max span setting
 14.4KΩ @ 51% max. span setting
Excitation Voltage 25 Volts Max. AC or DC
Output Voltage User adjustable to a maximum of 18% of Input Voltage

Environmental

Thermal Coefficient of Sensing Element ±100 PPM/°C Max.
Operating Temperature -25°C to 95°C
Operating Humidity 100%
Shock 50 G @ 0.1 ms Max.
Vibration 10 Hz to 2000 Hz, 15 G peak
Ingress Protection	
Exclusive of Wire Rope Area NEMA 4 (IP-65)
Optional Ingress Protection NEMA 6 (IP-68)

HX-P420 SERIES

4 to 20 mA OUTPUT

The HX-P420 position transducer provides a 4 to 20 mA output signal with a potentiometric sensor. The HX-P420 is particularly advantageous in electrically noisy environments. Since the transmitter is loop powered, an assembled system consists of a power supply, current monitor, and transmitter all connected in series. Zero and span adjustments allow setting the 4 mA position within the first 30% of total travel and setting the 20 mA position within 80% to 100% of total travel. The HX-P420 may be powered with a supply voltage in the range of 12 to 35 VDC subject to the total loop resistance.

SPECIFICATIONS

General

Available Measurement Ranges	See Table 4, Page 8
Connector	MS3102E-14S-6P
Mating Connector (included)	MS3106E-14S-6S

Performance

Linearity	
2", 3", 4" & 5" Ranges	±0.30% Full Scale
10", 15", 20" & 25" Ranges	±0.20% Full Scale
All other ranges	±0.15% Full Scale
Repeatability	±0.015% Full Scale
Resolution	Essentially Infinite

Electrical

Output	User Adjustable 4 to 20 mA
Excitation Voltage	12 to 35 VDC
Min. Supply Voltage	(.02 x Load Res.) + 12 VDC
Insulation Resistance	100 Megohms min. at 100 VDC
Adjustment Range	
4 mA	0 to 30% of Range
20 mA	80% to 100% of Range
Protection	Reversed Polarity

Environmental

Thermal Coefficient of sensing element	±100 PPM/°C max.
Operating temperature	-25°C to 80°C
Operating humidity	100%
Vibration	15 G's 0.1 ms max.
Shock	50 G's 0.1 ms max.
Ingress Protection	
Exclusive of Wire Rope Area	NEMA 4 (IP-65)
Optional Ingress Protection	NEMA 6 (IP-68)

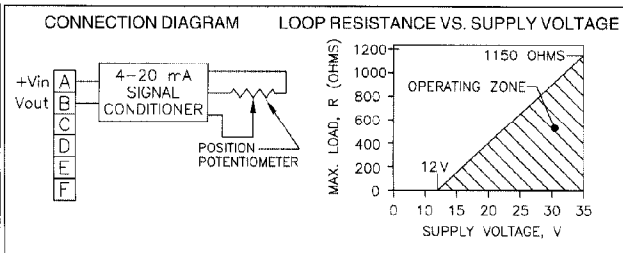

MODEL NUMBER CONFIGURATION

HX-P420- - - -

Measurement Range Designator from standard ranges shown in Table 4, page 8

Option designators from **OPTIONS** list (page 9) in order of appearance on **OPTIONS** list

HX-P510 SERIES

0 to 5 VDC or 0 to 10 VDC OUTPUT

The HX-P510 position transducer provides a 0 to 5 or 0 to 10 VDC output utilizing a potentiometric sensor. Pins B and C of the connector are both COMMON and are connected together internally at the transducer enabling a three or four wire connection. With adjustable zero and span, zero position may be set within the first 30% of the total measurement range. The span allows maximum output voltage to be adjusted to 5 VDC or 10 VDC for displacements between 80% and 100% of total range. The HX-P510 may be powered by an unregulated supply voltage in the range of 11 to 35 VDC.

SPECIFICATIONS

General

Available Measurement Ranges	See Table 4, Page 8
Sensing Device	Precision Potentiometer
Connector	MS3102E-14S-6P
Mating Connector (included)	MS3106E-14S-6S

Performance

Linearity	
2", 3", 4" & 5" Ranges	±0.30% Full Scale
10", 15", 20" & 25" Ranges	±0.20% Full Scale
All other ranges	±0.15% Full Scale
Repeatability	±0.015% Full Scale
Resolution	Essentially Infinite

Electrical

Output	0 to 5 VDC adjustable to 10 VDC
Excitation Voltage	11 to 35 VDC
Excitation Current	40 mA max.
Output Impedance	10Ω max.
Output Load	5KΩ min.
Insulation resistance	100 megohms min. at 100 VDC
Zero Adjustment Range	0 to 30% of Range
Span ² Adjustment Range	80% to 100% of Range
Protection	Reversed Polarity

Environmental

Operating temperature	0°C to 55°C
Storage Temperature	-40° to 70°C
Operating humidity	100%
Vibration	15 G's 0.1 ms max.
Shock	50 G's 0.1 ms max.
Ingress Protection	
Exclusive of Wire Rope Area	NEMA 4 (IP-65)
Optional Ingress Protection	NEMA 6 (IP-68)

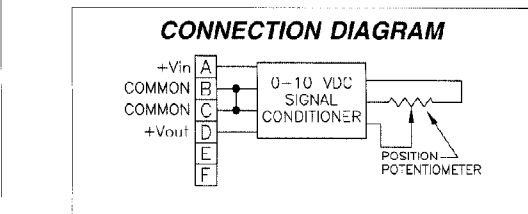

MODEL NUMBER CONFIGURATION

HX-P510- - - -

Measurement Range Designator from standard ranges shown in Table 4, page 8

Option designators from **OPTIONS** list (page 9) in order of appearance on **OPTIONS** list

HX-P1010 SERIES



±10VDC OUTPUT (Adjustable to ±5 VDC)

(SPECIFICATIONS)

The UniMeasure HX-P1010 series position transducer provides an output voltage from -10 VDC to +10 VDC with adjustability to -5 VDC to +5 VDC. The zero position may be set within 10% to 90% of the total range of the transducer. The output voltage will be positive when the cable is extending from the zero position and negative when retracting from the zero position. The span may be adjusted to the maximum output voltage within 50% to 100% of the longest possible travel from the zero position, whether positive or negative.

A dual voltage input (+15 VDC, -15 VDC and COMMON) is required but optional single excitation voltages of +5, +12, +15, or +24 VDC are available. With optional single input voltages, the power supply ground is isolated from the output common.

General

- Available Measurement Ranges See Table 4, Page 8
- Connector MS3102E-14S-6P
- Mating Connector (included) MS3106E-14S-6S

Performance

- Linearity
 - 2", 3", 4" & 5" Ranges ±0.30% Full Scale
 - 10", 15", 20" & 25" Ranges ±0.20% Full Scale
 - All other ranges ±0.15% Full Scale
- Repeatability ±0.015% Full Scale
- Resolution Essentially Infinite

Electrical

- Output -10 VDC to +10 VDC
- Excitation Voltage +15 VDC ±10%, -15 VDC ±10%
- Input Current 25 mA max.
- Output Impedance 1.0Ω max.
- Output Load 5KΩ min.
- Capacitive Load 1000 pF
- Zero Adjustment Range 10% to 90% of Range
- Span Adjustment Range 50% to 100% of Longest Possible Travel from Zero Position
- Protection Reversed Polarity
- Temperature Stability 0.02%/°C of Span

Environmental

- Operating temperature 0°C to +70°C
- Storage Temperature -40°C to +85°C
- Operating humidity 100%
- Vibration 15 G's 0.1 ms max.
- Shock 50 G's 0.1 ms max.
- Ingress Protection
 - Exclusive of Wire Rope Area NEMA 4 (IP-65)
 - Optional Ingress Protection NEMA 6 (IP-68)

CONNECTION DIAGRAM

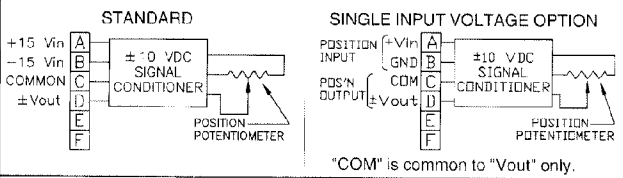

MODEL NUMBER CONFIGURATION
HX-P1010- - -

Measurement Range Designator
from standard ranges shown in Table 4, page 8

Optional Single Input Voltage from Table 1
(Omit for standard input configuration)

Option designators from **OPTIONS** list (page 9) in order of appearance on **OPTIONS** list

TABLE 1 ----- OPTIONAL SINGLE INPUT VOLTAGES

Option Designator	Input Voltage	Input Current (mA max.)
SI5	+5	150
SI12	+12	65
SI15	+15	50
SI24	+24	32

SELF-SEALING SCREW

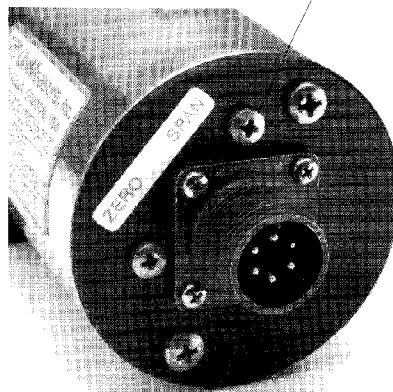

On models with zero and span controls (HX-PB, IIX-P420, HX-P510, HX-P1010), access to zero and span adjustments is accomplished by removing o-ring sealing screws.

HX-EP SERIES



DIGITAL OUTPUT

Utilizing an incremental encoder as the sensor, the UniMeasure HX-EP series position transducer provides a two channel square wave current sinking output signal in quadrature. The standard output is a single-ended TTL compatible square wave with 2KΩ pullup resistors provided internally. The resolution values shown in the specifications table indicate resolution for times 1 counting mode where a count is registered for one up transition in channel A. With interface electronics capable of times 2 or times 4 counting mode, a true resolutional increase of 2 or 4 may be obtained. For example, the HX-EP-50 has a resolution of approximately .004" per count in times 1 counting mode whereas the resolution is approximately .001" per count in times 4 counting mode.

The actual resolution of a HX-EP transducer differs from unit to unit because of tolerances associated with the wire rope diameter and the capstan upon which the wire rope winds. The nylon jacketed wire rope option will have the effect of slightly reducing the resolution. Linearity and repeatability remain independent of resolution. In applications where the output count is interpreted as a percentage of total travel, resolutional differences from unit to unit are not critical. However, in applications where the digital output is to be interfaced to a digital display to give an output in engineering units, the calibration constant supplied with the transducer may be used to calculate a suitable scale multiplier to produce the correct engineering units.

Alternative outputs shown in the "Optional Outputs" table below are available to facilitate interfacing to a variety of different types of equipment.

General

Available Measurement Ranges See Table 4, Page 8
 Connector MS3102E-14S-6P
 Mating Connector (included) MS3106E-14S-6S

Performance

Linearity ±0.03% Full Scale
 Repeatability ±0.015% Full Scale
 Resolution See Table Below

Electrical

Input Voltage +5 VDC ±5%
 Input Current 125 mA Maximum
 Output Current sinking (20 mA max.) two channel single-ended TTL square wave from LM339 open collector output stage. 2 KΩ internal pullup resistors provided.
 Phase Quadrature 90°±20°

Environmental

Operating temperature 0°C to 70°C
 Storage temperature -25°C to 90°C
 Shock 50 G's for 11 ms Duration
 Vibration 20 Hz to 2000 Hz @ 5G's
 Humidity 100%
 Ingress Protection
 Exclusive of Wire Rope Area NEMA 4 (IP-65)
 Optional Ingress Protection NEMA 6 (IP-68)

SPECIFICATIONS

TABLE 2 ----- RESOLUTION

MODEL	RANGE		RESOLUTION ¹		TOLERANCE ¹ ON
	(inch)	(mm)	(counts/inch)	(counts/mm)	RESOLUTION
HX-EP-10	10	250	500.0	19.69	±0.30%
HX-EP-25	25	640	250.0	9.84	±0.20%
HX-EP-50	50	1250	250.0	9.84	±0.20%
HX-EP-60	60	1.5 m	205.8	8.10	±0.20%
HX-EP-80	80	2.0 m	155.2	6.11	±0.20%
HX-EP-100	100	2.5 m	82.9	3.26	±0.20%
ALL RANGES GREATER THAN 100 ¹	100	2.5 m	82.9	3.26	+0.20%

1. The resolution shown is a calculated number based upon the capstan diameter, wire rope diameter and line count of the encoding device. The tolerance on the resolution accounts for resolutional differences from unit to unit due to manufacturing tolerances on the capstan and wire rope. In practice, the output count in a given unit of travel is an integer.

MODEL NUMBER CONFIGURATION

HX-EP- - -

Measurement Range Designator Options designators from Table 4, page 8
OPTION S list (page 9) in order of appearance on OPTIONS list
Output Option (Omit for standard output) Use option designator from column A in "Optional Outputs" table below

A Optional Outputs

"I"	Index Channel Adds index (Z) channel. Index is triggered within the first 0.25" (6 mm) of extension of the wire rope. Triggers repeatedly for each complete rotation of the internal capstan. See STANDARD OUTPUT box for output stage, waveform and connector wiring.
"H1"	8 to 28 VDC Current Sinking 35 mA current sinking output with 10KΩ internal pullup resistors. 8 to 28 VDC input voltage
"H2"	5 VDC TTL Differential Line Drive Current Sinking Line driver output. 35 mA current sinking capability with 2KΩ internal pullup resistors. 5 VDC input voltage
"H3"	8 to 28 VDC Differential Line Drive Current Sinking Line driver output. 35 mA current sinking with 10KΩ internal pullup resistors. 8 to 28 VDC input voltage
"H5"	5 VDC Push-Pull Push-Pull circuit with 20 mA current sourcing and 20 mA current sinking capability. +5 VDC input voltage

STANDARD OUTPUT

CONNECTOR WIRING

- A +Vin
- B COMMON
- C CHANNEL A
- D CHANNEL B
- E CHANNEL Z
- F N.C.

Quadrature 90°±20°
 Symmetry 180°±10°

CONNECTOR WIRING

- A +Vin
- B COMMON
- C CHANNEL A
- D CHANNEL B
- E N.C.
- F N.C.

CONNECTOR WIRING

- A +Vin
- B COMMON
- C CHANNEL A
- D CHANNEL B
- E CHANNEL B
- F CHANNEL B

HX-V SERIES

UniMeasure

VELOCITY OUTPUT

The UniMeasure HX-V series linear velocity transducer incorporates a self-generating tachometer which eliminates the need for any external power supply. Extra long brush life, excellent stability and a wide operating temperature range make the V series transducer highly reliable for long term service.

TABLE 3 ----- VELOCITY OUTPUT

MEASUREMENT RANGE DESIGNATOR	RANGE		VELOCITY OUTPUT	
	(in)	(mm)	(mV per 100 in/min)	(mV per r/min)
2, 10	10	250	333	131
3, 15, 30	15	390	227	89
4, 20, 40	20	500	171	67
5, 25, 50	25	640	137	54
60	60	1500	115	45
80	80	2000	87	34
100	100	2500	300	118
ALL RANGES GREATER THAN 100"	100	2500	300	118

MODEL NUMBER CONFIGURATION

HX-V- - - -

Measurement Range Designator
from standard ranges shown in
Table 4, page 8

Option designators from
OPTIONS list (page 9) in order of
appearance on **OPTIONS** list

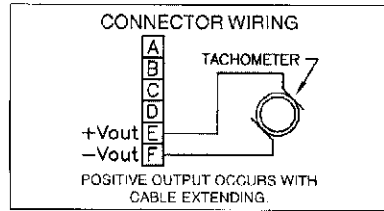

HX-VPA SERIES

VELOCITY-POSITION OUTPUT

The UniMeasure HX-VPA series combines a self-generating tachometer and a precision potentiometer to give an output of both velocity and analog position. Standard position output is ratiometric voltage. Optionally available position outputs include ratiometric voltage from a bridge circuit, 4 to 20 mA, 0 to 10 VDC, and ± 10 VDC. See HX-PB, HX-P420, HX-P510 and HX-P1010 data sheets for electrical specifications.

General

Available Measurement Ranges See Table 4, Page 8
Connector MS3102A-14S-6P
Mating Connector (included) MS3106E-14S-6S

SPECIFICATIONS

Performance

Positional Linearity
2", 3", 4" & 5" Ranges +0.25% Full Scale
10", 15", 20" & 25" Ranges $\pm 0.15\%$ Full Scale
All other ranges +0.10% Full Scale
Repeatability $\pm 0.015\%$ Full Scale
Positional Resolution Essentially Infinite

Electrical (Position)

Input Impedance ("A" Circuit) $1000\Omega \pm 10\%$
Output Impedance ("A" Circuit) 0 to 1000Ω
Excitation Voltage 25 Volts Max. AC or DC
Nominal Output Voltage $\frac{990}{\text{Range in Inches}}$ mV/V/inch
(Use total measurement range in calculation) $\frac{990}{\text{Range in mm}}$ mV/V/mm

Electrical (Velocity)

Output See Table 3, above
Linearity $\pm 0.10\%$ F.S. within 25 Volt Output
Ripple 3% Max.
Output Impedance 350Ω

Environmental

Thermal Coeff't of potentiometer ± 100 PPM/ $^{\circ}$ C max.
Operating temperature -20° C to 95° C
Operating humidity 100%
Vibration 15 G's 0.1 ms max.
Shock 50 G's 0.1 ms max.
Ingress Protection
Exclusive of Wire Rope Area NEMA 4 (IP-65)
Optional Ingress Protection NEMA 6 (IP-68)

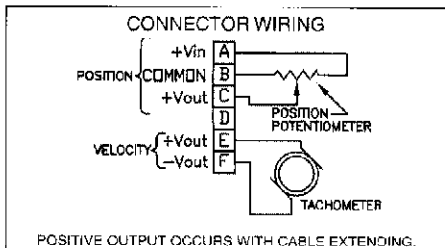

MODEL NUMBER CONFIGURATION

HX-VPA- - - -

For optional output, replace
VPA with: VPB
VP420
VP510
VP1010

Option designators from
OPTIONS list (page 9) in order of
appearance on **OPTIONS** list

Measurement Range Designator
from standard ranges shown in
Table 4, page 8

HX

UniMeasure

MECHANICAL SPECIFICATIONS

SPECIFICATIONS

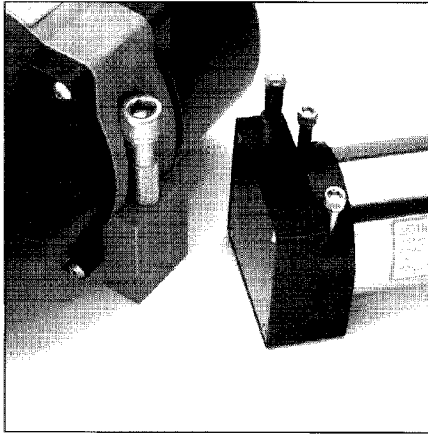

Typical HX mounting bolts.

Mechanical Specifications

- Available Measurement Ranges See Table 4
- Construction
 - Ranges 80" (2 m) and under Anodized Aluminum Mounting Base, Stainless Steel & Anodized Aluminum Housing
 - Ranges 100" (2.5 m) and greater Stainless Steel Mounting Base High Impact, Corrosion Resistant Polyurethane Housings
- Wire Rope Tension See Table 4
- Wire Rope Diameter See Table 4
- Weight See Table 4
- Connector MS3102A-14S-6P
- Mating Connector (included) MS3106E-14S-6S
- Optional NEMA 6 Capability Bulkhead fitting with 8' (2.5 m) of shielded, twisted pair cable

When configuring model number:

Use value from this column to indicate overall measurement range

Check mark indicates available measurement range

TABLE 4

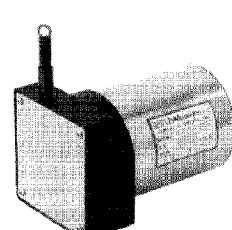
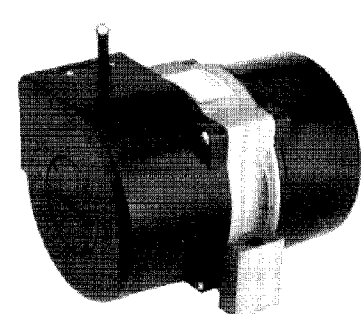
MEASUREMENT RANGE DESIGNATOR	STANDARD MEASUREMENT RANGES		APPLICABLE SERIES			WIRE ROPE TENSION (NOMINAL)		WIRE ROPE DIAMETER		WEIGHT		DIMENSIONAL INFORMATION	
	(in)	(mm)	HX-PA HX-PB HX-P420 HX-P510 HX-P1010	HX-EP	HX-V HX-VP	(oz)	(N)	(in)	(mm)	(lb)	(Kg)		
2	2	50	✓	-	✓	34	9.4	.016	0.4	2	0.9	 See Fig. 1, Page 10 for Dimensional Information	
3	3	75	✓	-	✓	24	6.7	.016	0.4	2	0.9		
4	4	100	✓	-	✓	24	6.7	.016	0.4	2	0.9		
5	5	125	✓	-	✓	19	5.3	.016	0.4	2	0.9		
6	6	150	✓	-	✓	24	6.7	.016	0.4	2	0.9		
10	10	250	✓	✓	✓	34	9.4	.016	0.4	2	0.9		
15	15	390	✓	-	✓	24	6.7	.016	0.4	2	0.9		
20	20	500	✓	-	✓	24	6.7	.016	0.4	2	0.9		
25	25	640	✓	✓	✓	19	5.3	.016	0.4	2	0.9		
30	30	750	✓	-	✓	24	6.7	.016	0.4	2	0.9		
40	40	1000	✓	-	✓	24	6.7	.016	0.4	2	0.9		
50	50	1250	✓	✓	✓	19	5.3	.016	0.4	2	0.9		
60	60	1500	✓	✓	✓	24	6.7	.016	0.4	2	0.9		
80	80	2.0m	✓	✓	✓	21	5.8	.016	0.4	2	0.9		
100	100	2.5m	✓	✓	✓	36	10.0	.024	0.6	6.8	3.1		 See Fig. 2, Page 10 for Dimensional Information
120	120	3.0m	✓	✓	✓	36	10.0	.024	0.6	6.8	3.1		
150	150	3.8m	✓	✓	✓	36	10.0	.024	0.6	6.8	3.1		
200	200	5.0m	✓	✓	✓	36	10.0	.024	0.6	6.8	3.1		
250	250	6.3m	✓	✓	✓	36	10.0	.024	0.6	6.8	3.1		
300	300	7.5m	✓	✓	✓	36	10.0	.024	0.6	6.8	3.1		
350	350	8.8m	✓	✓	✓	36	10.0	.024	0.6	6.8	3.1		
400	400	10.0m	✓	✓	✓	36	10.0	.024	0.6	6.8	3.1		
500	500	12.5m	✓	✓	✓	36	10.0	.024	0.6	8.6	3.9		
600	600	15.2m	✓	✓	✓	36	10.0	.024	0.6	8.6	3.9		
800	800	20.3m	✓	✓	✓	36	10.0	.024	0.6	8.6	3.9		
1000	1000	25.4m	✓	✓	-	36	10.0	.024	0.6	12.0	5.4		
1200	1200	30.4m	✓	✓	-	36	10.0	.024	0.6	12.3	5.6		
1600	1600	40.6m	✓	✓	-	36	10.0	.024	0.6	14.1	6.4		
1800	1800	45.7m	✓	✓	-	36	10.0	.021	0.6	15.9	7.2		
2000	2000	50.8m	✓	✓	-	36	10.0	.021	0.5	16.3	7.4		

Specifications subject to change without notice.

HX

UniMeasure

OPTIONS

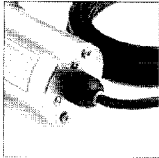
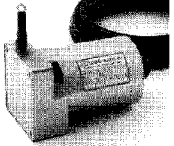
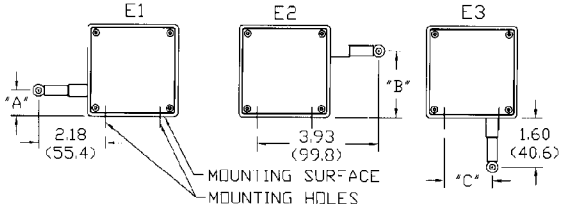
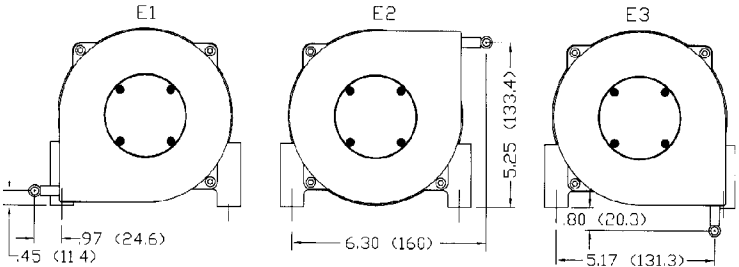
OPTION	OPTION DESIGNATOR	DESCRIPTION																												
Nylon jacketed wire rope (Ranges to 80")	NJC	Replaces standard stainless steel wire rope with Ø.018 nylon jacketed wire rope. This option increases wire rope life dramatically but may increase non-linearity by as much as ±.05% of full scale.																												
Nylon jacketed wire rope (Ranges 100" to 400" only)	NJC037	Replaces standard stainless steel wire rope with Ø.037 nylon jacketed wire rope.																												
Reversed output	R	Output is at a maximum when wire rope is fully retracted. Output decreases as wire rope is extended. Does not apply to velocity signal.																												
NEMA 6, IP-68 capability	N6	 <p>Connector is replaced with a bulkhead fitting and 8' (2.4 m) of urethane jacketed, shielded, twisted pair cable. Retraction mechanism and electrical components are sealed to NEMA 6, IP-68 capability.</p>																												
Stainless steel construction (Ranges to 80" only)	SS	 <p>All anodized aluminum parts on transducer housing are replaced with stainless steel. Transducer is sealed to NEMA 6, IP-68 capability. Eight feet (2.4 m) of urethane jacketed, shielded, twisted pair cable exits unit. No connector.</p>																												
Non-standard potentiometer (Applies to HX-PA only)	PXK	<p>Replace "X" in option designator with required potentiometer value in K ohms. Non-standard potentiometer linearity is as follows:</p> <p>Ranges 0 to 2" to 0 to 5" ±1.00% of full scale Ranges 0 to 10" to 0 to 25" ±0.50% of full scale Ranges 30" and above ±0.25% of full scale</p> <p>Note: This option is subject to potentiometer availability.</p>																												
Alternate wire rope exit Measurement ranges to 80" (2.0 m)	E1, E2, E3 Specify from orientation shown.	 <table border="1"> <thead> <tr> <th>RANGE</th> <th>"A"</th> <th>"B"</th> <th>"C"</th> </tr> </thead> <tbody> <tr> <td>2", 10"</td> <td>1.12 (28.4)</td> <td>1.79 (45.5)</td> <td>1.21 (30.7)</td> </tr> <tr> <td>3", 15", 30"</td> <td>.96 (24.4)</td> <td>1.95 (49.5)</td> <td>1.37 (34.8)</td> </tr> <tr> <td>4", 20", 40"</td> <td>.80 (20.3)</td> <td>2.11 (53.6)</td> <td>1.53 (38.9)</td> </tr> <tr> <td>5", 25", 50"</td> <td>.64 (16.3)</td> <td>2.27 (57.7)</td> <td>1.69 (42.9)</td> </tr> <tr> <td>60"</td> <td>.49 (12.4)</td> <td>2.42 (61.5)</td> <td>1.84 (46.7)</td> </tr> <tr> <td>80"</td> <td>.25 (6.4)</td> <td>2.66 (67.6)</td> <td>2.08 (52.8)</td> </tr> </tbody> </table> <p>Dimensions in brackets are millimeters.</p>	RANGE	"A"	"B"	"C"	2", 10"	1.12 (28.4)	1.79 (45.5)	1.21 (30.7)	3", 15", 30"	.96 (24.4)	1.95 (49.5)	1.37 (34.8)	4", 20", 40"	.80 (20.3)	2.11 (53.6)	1.53 (38.9)	5", 25", 50"	.64 (16.3)	2.27 (57.7)	1.69 (42.9)	60"	.49 (12.4)	2.42 (61.5)	1.84 (46.7)	80"	.25 (6.4)	2.66 (67.6)	2.08 (52.8)
RANGE	"A"	"B"	"C"																											
2", 10"	1.12 (28.4)	1.79 (45.5)	1.21 (30.7)																											
3", 15", 30"	.96 (24.4)	1.95 (49.5)	1.37 (34.8)																											
4", 20", 40"	.80 (20.3)	2.11 (53.6)	1.53 (38.9)																											
5", 25", 50"	.64 (16.3)	2.27 (57.7)	1.69 (42.9)																											
60"	.49 (12.4)	2.42 (61.5)	1.84 (46.7)																											
80"	.25 (6.4)	2.66 (67.6)	2.08 (52.8)																											
Alternate wire rope exit Measurement ranges 100" (2.5 m) and greater.	E1, E2, E3 Specify from orientation shown.	 <p>Dimensions in brackets are millimeters.</p>																												

HX

UniMeasure

DIMENSIONAL INFORMATION

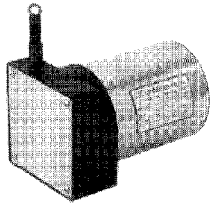

Measurement Ranges to 80" (2 m)

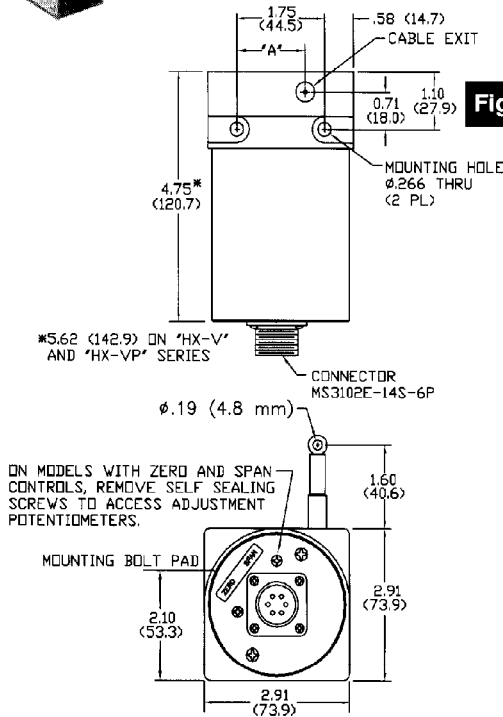
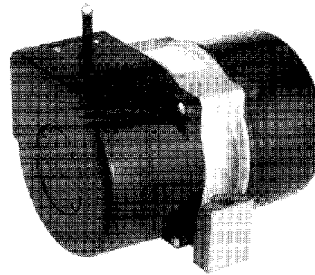

Fig. 1



Measurement Ranges 100" (2.5 m) and greater

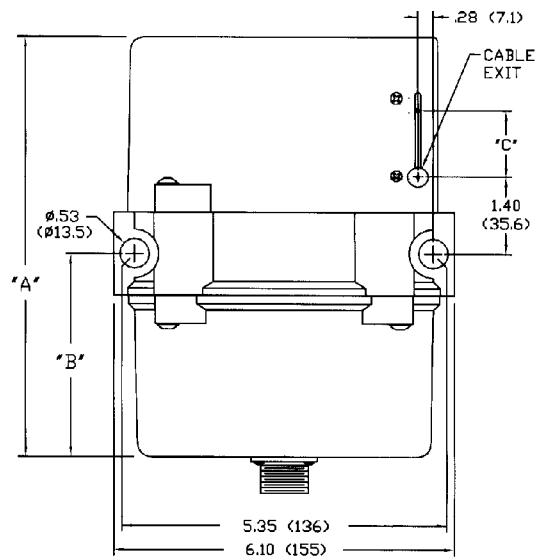

Fig. 2

Notes

1. Transducer mounts with Ø.25 or M6 socket head cap bolts.

RANGE	"A"
2", 10"	1.21 (30.7)
3", 15", 30"	1.37 (34.8)
4", 20", 40"	1.53 (38.9)
5", 25", 50"	1.69 (42.9)
60"	1.84 (46.7)
80"	2.08 (52.8)

RANGE	DIM "A"	DIM "B"
Ranges to 800"	7.70 (19.6)	3.80 (96.5)
1000" to 2000"	11.0 (280.0)	5.60 (142.0)

Notes

1. Transducer mounts with Ø.50 or M12 socket head cap bolts.
2. Dimension "C" is the cable offset that occurs as the cable is extended from the transducer.

For "C" in inches, $C = .0016 \times E$ where E = extension in inches.
For "C" in millimeters, $C = .0016 \times E$ where E = extension in mm.

ON MODELS WITH ZERO AND SPAN CONTROLS, REMOVE SELF SEALING SCREWS TO ACCESS ADJUSTMENT POTENTIOMETERS.

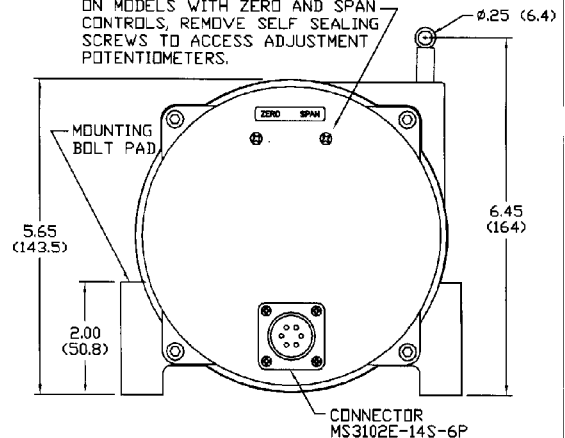

Dimensions in brackets are millimeters.

Specifications subject to change without notice.

Мы оставляем право изменять характеристики без предварительного уведомления.